



SIT Group

# 5 0 1 E F D



Electronic Flame  
Failure Device



5 0 1 E F D

DESCRIPTION

FEATURES

SEQUENCE OF  
OPERATIONS

TECHNICAL  
DATA

INSTALLATION

# DESCRIPTION

The 501 EFD automatic direct burner ignition (DBI) unit has been designed for atmospheric and fan assisted burners which require non volatile lock-out.

This SIT Flame Failure Device is a solid state controller based on the well known and proven rectification effect of flame ionization.

A suitable design and a special components selection has allowed SIT to obtain a wide temperature range from -20 to + 80 °C.

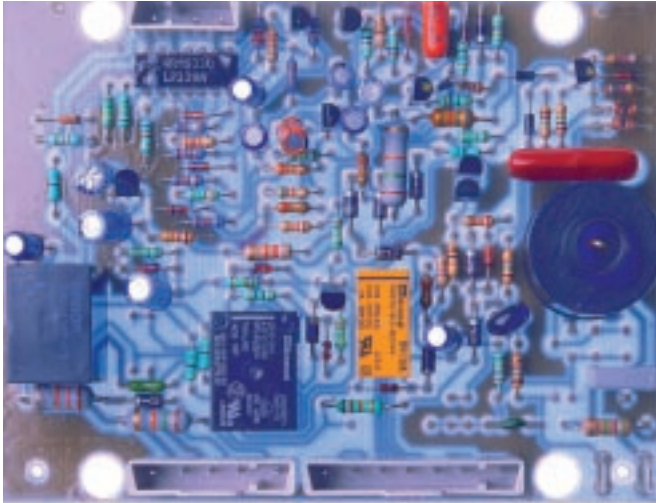

### **Applications**

The 501 EFD provides automatic ignition control with non volatile lock-out for intermittent operation in accordance with EN 298 for:

- Atmospheric burners
- Fan-assisted boilers, including dynamic air check

---

---

---

---

---

---

---

---

---

---

### **Basic features include**

- Compact design
- Remote, manual reset function
- Multiple plug-in connectors
- Well established electronic technology for high reliability
- Atmospheric burner applications
- Trial for ignition after flame loss
- Permanent lock-out visualization, also without thermostat input
- Wide range of operating ambient temperature

### **Options available**

- Contact for flame indication relay from the power supply line
- Fan output and air pressure switch check
- Potted version
- Single electrode (for ignition and flame detection)
- Different flame current sensitivity can be provided upon request
- Fast-on connectors
- Several pre-purge and safety timings can be tailored to the application

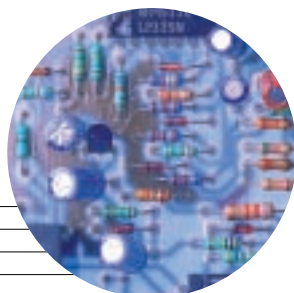

# FEATURES

# SEQUENCE OF OPERATIONS

## ATMOSPHERIC DBI APPLICATION

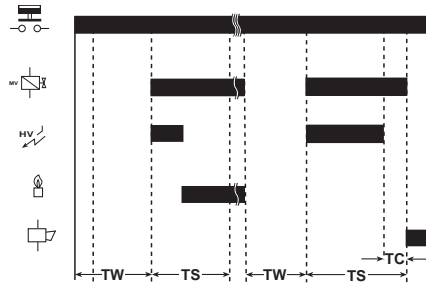

## FAN-ASSISTED DBI APPLICATION

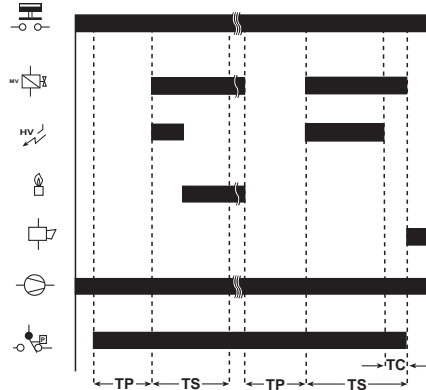

### Normal operation (atmospheric or fan assisted)

During the waiting or purge time,  $T_w$  or  $T_p$ , the circuitry verifies that there is no parasitic flame signal present. If the unit is used in a fan assisted application, the air pressure switch is verified to be in the N.C. (normally closed) or “no flow” position. Upon powering the fan, the unit will not begin the operating sequence until the N.O. (normally open) or “flow” position is activated on the air pressure switch. After the scheduled waiting time  $T_w$ , or purge time  $T_p$ , the built-in ignitor and the gas valve are energized. This commences the safety time,  $T_s$ . The ignition spark will ignite the gas and the flame will be sensed by the HV electrode (single probe model) or the detection electrode (dual probe model). Upon sensing the flame, the HV spark will be suppressed and the gas valve will remain energized. On units with a flame relay, the flame detecting connection will be powered when the flame is established. When the thermostat is satisfied, the valve and fan are de-energized and the control returns to the standby mode.

### Behaviour under abnormal conditions

- if the air proving switch is in the N.O. (normally open) or “flow” position at startup, upon a request for heat, the unit will remain in a waiting mode with the fan de-energized
- if air flow is not proven by the airflow switch after energizing the fan, the unit control will remain in the waiting mode with the fan energized until the air flow is sensed
- upon flame failure during normal operation, the unit will maintain the power to the fan and start again the ignition sequence with a waiting time (or purge time) followed by a safety time
- if flame is not established and sensed during the beginning of  $T_s$ , the spark will be suppressed shortly before the programmed end of the safety time to permit the sensing of extremely weak flames. This time is referred to as  $T_c$  (check time). If no flame is sensed during any part of the safety time, the unit will lockout

### Resetting the unit

To reset the unit the external reset switch is depressed. If a first reset is not successful, wait at least 10 seconds before the next attempt. Before starting, check if control is locked-out. If locked-out, depress the reset button; After a manual reset an extended pre-purge waiting time will occur.

## AMBIENT TEMPERATURE

-20 to + 80 °C

## HUMIDITY

95% max at 40 °C

## SUPPLY VOLTAGE

230 Vac -15%, +10%, 50-60 Hz

## POWER CONSUMPTION

10 VA

## ELECTRICAL RATINGS

valve output: 230 Vac, 0,5 A, cosφ=0,6

fan output: 230 Vac, 0,5 A, cosφ=0,6

flame relay output: 230 Vac, 0,5 A, cosφ=0,6

alarm output: 230 Vac, 0,5 A, cosφ=1

## ELECTRICAL CONNECTIONS

high voltage probe: fast-on 2,8X0,5 mm

connectors: - STELVIO/STOCKO multiple plug-in connectors, or  
- fast-on connectors 6,3 X 0,8 mm.

## PROTECTION CLASS

IP 00 (fast-on)

IP 20 (connectors)

## TIMING

minimum waiting time Tw: 1,5-3-5-7-10-30 sec.

minimum pre-purge time Tp: 1,5-3-5-7-10-30 sec.

maximum safety time Ts: 5-7-10 sec.

## FLAME SENSING

minimum flame current: 0,5 µA

recommended flame current: > 1 µA

## FUSING

internal: 2 A, non replaceable

external: 1,6 A fast. The 501 FFD should be externally fused to protect the unit

## IGNITION

Integral electronic spark generator.

ignition voltage: 15 KV at 30 pF load

repetition rate: 15 Hz +/- 20%

max. length of the cable: 2 m.

spark gap recommended: 2-4 mm.

## MOUNTING

No restriction for mounting position.

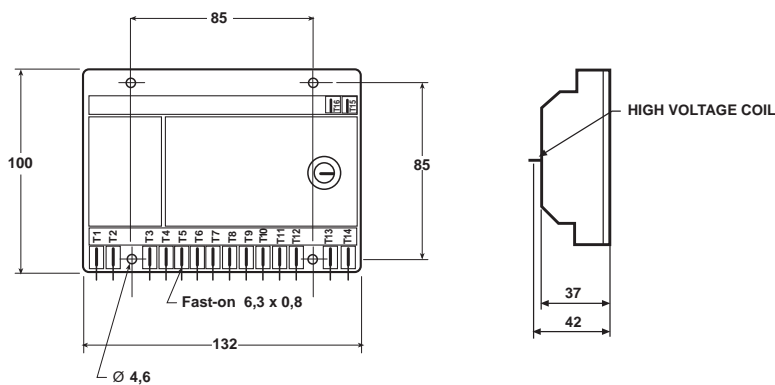

## WIRING DIAGRAM

STELVIO/STOCKO plug-in connectors

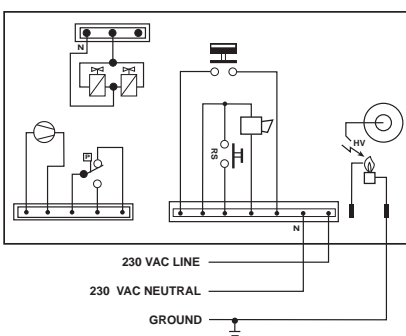

fast-on connectors

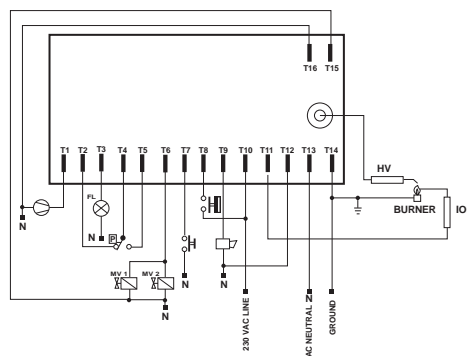

# TECHNICAL DATA

### General Notes

Before installing the 501 EFD read and follow the instructions carefully. Failure to follow the instructions could cause damage to the ignition module or the appliance in which it is installed. Make sure the ratings given in the technical data match the specifications of the appliance.



The person installing or replacing the ignition module must be a trained, experienced technician.

When the installation is complete, make sure that the ignition module operates properly in accordance to the normal operating sequence.

To ensure reliable long term operation, mount the 501 EFD in a low ambient temperature and low heat radiation position in the appliance. High temperatures could reduce product life.

For safety, connect a high limit thermostat in series with the power supply of the unit to de-energize the 501 EFD in case of excessive temperatures. To suppress radio frequency interference the 501 EFD and spark electrode cabling should be mounted in a shielded environment.

### Installation

The module should be mounted in such a way that it is not subjected to excessive heat, moisture, dust, grease or oil. It also should not be subjected to water or steam cleaning. The control should be mounted and shielded in a way that it will not get wet.

Excessive heat can damage the module and shorten the operating life of the

control. For applications that operate at high temperature, some insulation, shielding and forced air circulation may be necessary to keep the control operating properly.

### Wiring

The module should be mounted close enough to the burner to allow short direct routing of the high voltage cable. Use a suitable high voltage cable that conforms to national standards such as EN60335-1. The cable must not run in continuous contact with a metal surface or the spark voltage will be reduced. The necessary connections between the ignition control module and external loads should be made using thermoplastic insulated wire with a minimum rating of 105°C.

Disconnect power before making any wiring connections to prevent electrical shock or equipment damage.

Refer to the wiring diagram for detailed information on the exact connectors. The unit should be protected by an external quick acting fuse of appropriate ratings to prevent problems due, for example, to short circuit or faulty loads.

Note that a common ground is required between the burner and the ground terminal on the control module. Only one wire must connect the module ground terminal to the appliance common ground point.

The external loads and the burner must be connected to the same common ground point.

High voltage and probe electrodes should be mounted at the burner with a spark gap set according to the electrical specifications data.

### Flame check

The minimum flame ionization current is 0.5µA. For a stable flame detection this current under normal conditions should be higher than 1µA. To measure the ionization current connect a DC microammeter in series with the flame detection probe.

If the flame current is insufficient, check that the flame detection probe is fully in the flame.

Note that the flame detection is affected by the polarity of the connection to the main supply. For safety reasons, the flame is detected only with the correct line polarity connected to the control. Otherwise the unit will go to lockout at the end of the safety time, even if the burner is lit.

With single probe unit, to check the flame level measure the DC voltage between the probe and the ground with a flame present. Connect the positive lead to the probe and the negative to the ground. The voltage should be greater (more negative) than -25V. Note however that the input impedance of the suitable voltage meter must be more than 100MΩ.

---

---

---

---

---

---

---

---

---

---



5 0 1 E F D

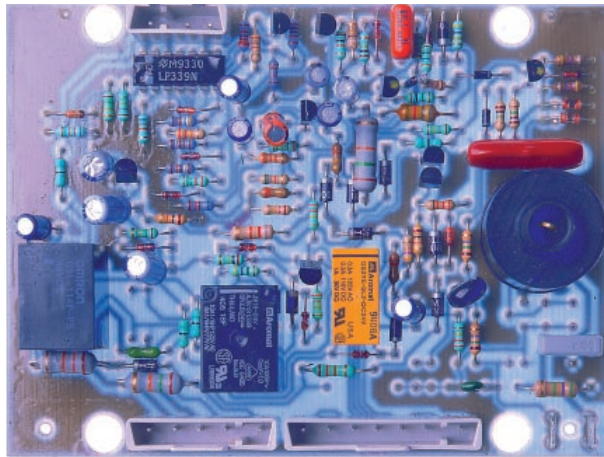



SIT La Precisa  
Viale dell'Industria 31/33  
35129 PADOVA - ITALY  
Tel. 049/8293111 - Fax 049/8070093 - Telex 430130 SITEC I